

Scan for Current Price Page



CUTTING ATTACHMENTS

TUBE MIX - V STYLE

REPLACEMENT TIP NUTS Go To Victor Welding & Cutting Outfits Page For Prices

Part # V080	Part # V081	Part # V082
Fits UNIWELD #'s		
780, (A), (B) 3-780, (A)	CA350 & 250	CA550
& VICTOR #'s		
CA2460, 246, 2462,2479	CA1350 & 1260	CA1250 (obsolete)

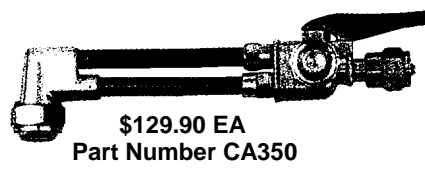
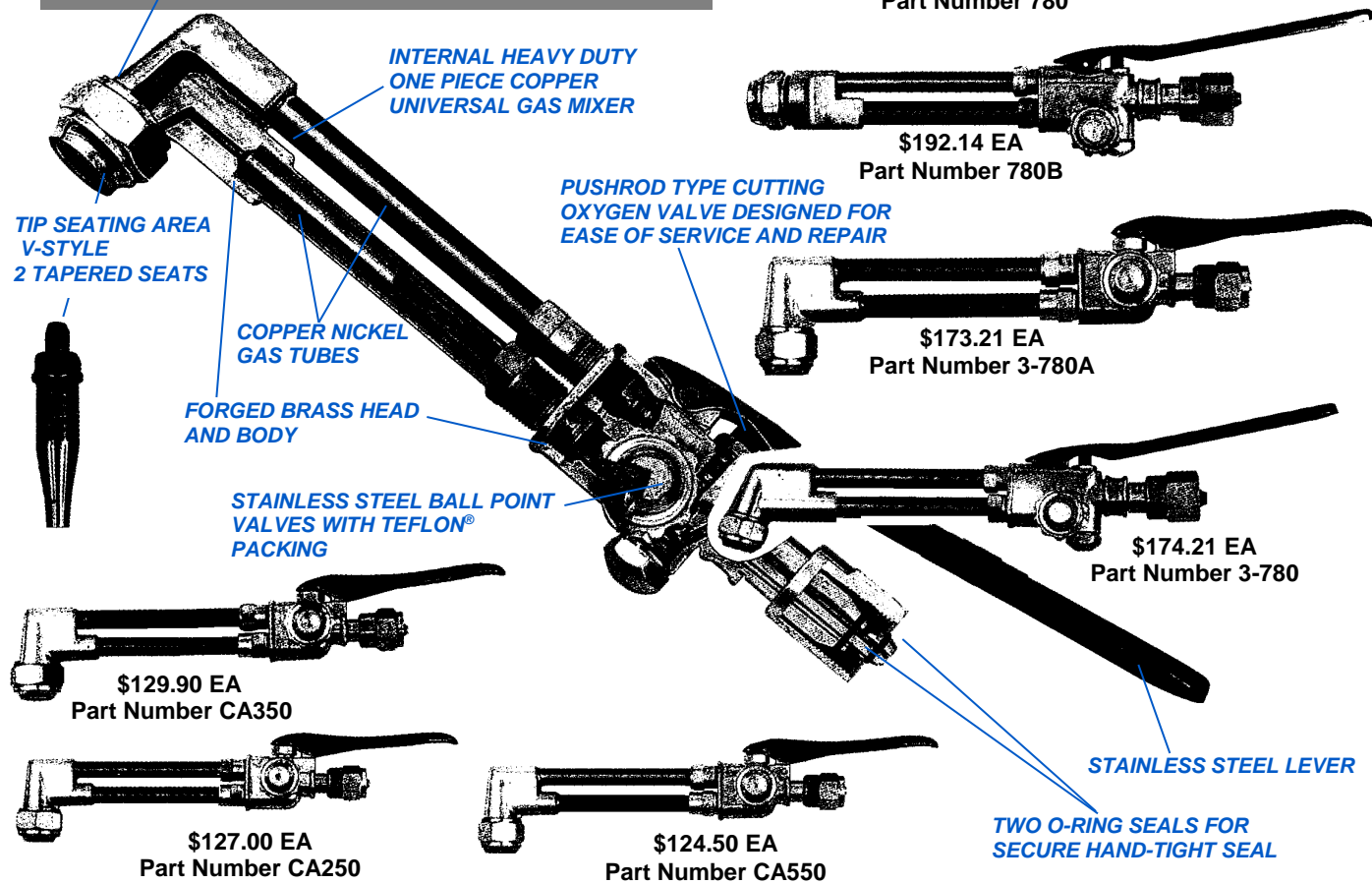
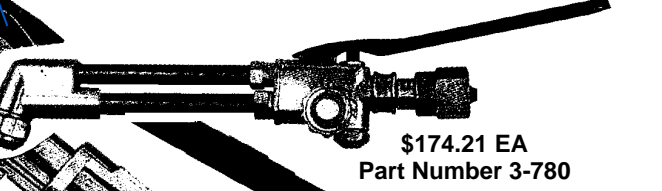
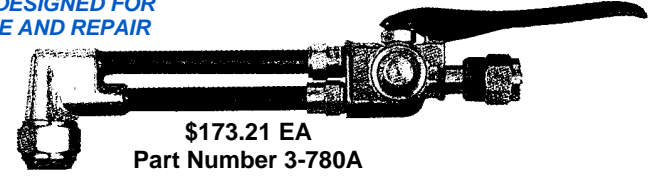
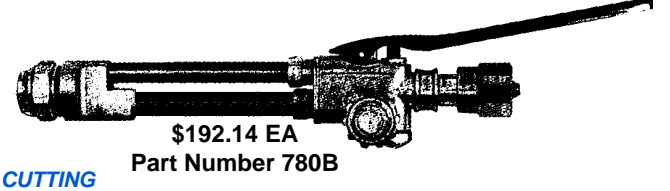
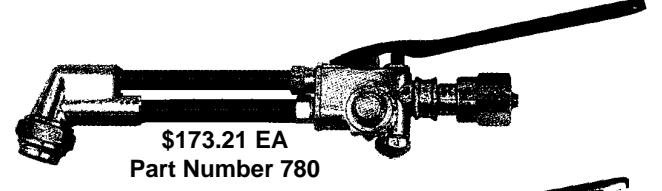
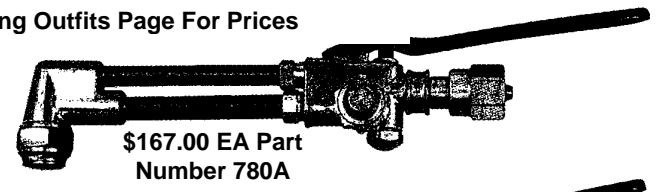

CUTTING ATTACHMENT SPECIFICATIONS

Part #	780A	780	780B	3-780A	3-780	CA350	CA250	CA550
Tip Series	1	1	1	3	3	3	3	5
Length	10-1/2"	10-1/2"	10-1/2"	10-1/2"	10-1/2"	8"	8"	8"
Weight	32oz.	32 oz.	32 oz.	31 oz.	31 oz.	15 oz.	15 oz.	15 oz.
Head Angle	90°	75°	180°	90°	75°	90°	90°	90°
Cutting Cap.	8"	8"	8"	7"	7"	6"	6"	2"
Compatible Torch Handles	WH360 WH360L 72L9 72L11	WH360 WH360L 72L9 72L11	WH360 WH360L 72L9 72L11	WH360 WH360L 72L9 72L11	WH360 WH360L 72L9 72L11	WH350	WH250 WH550 71	WH550 WH250 71
Handle Series	Type 4 (W)	Type 4 (W)	Type 4 (W)	Type 4 (W)	Type 4 (W)	Type 13 (W-1)	Type 17 (W-J)	Type 17 (W-J)